

Product Dimensions

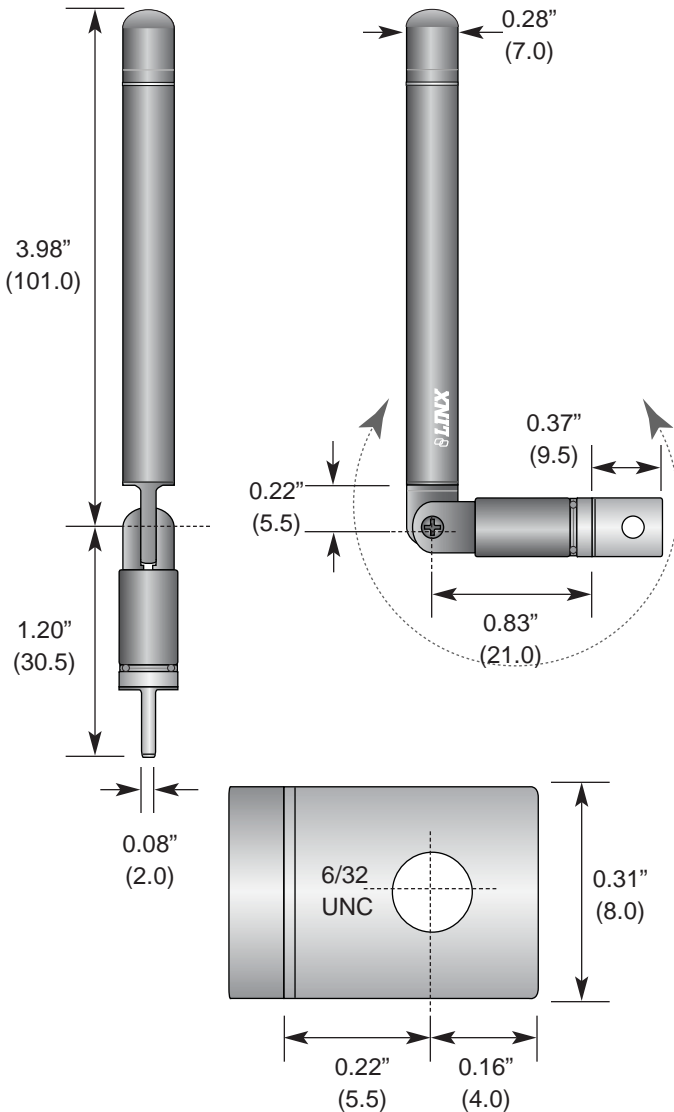

Recommended Footprint

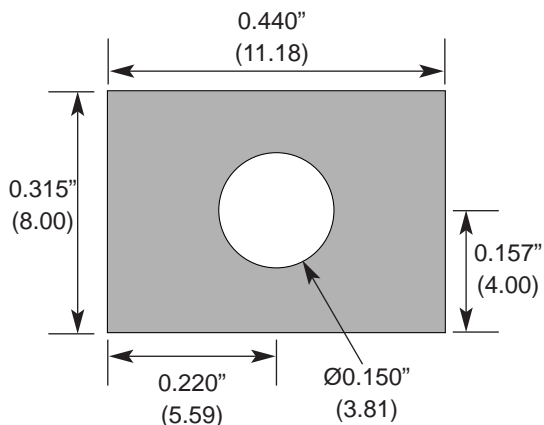

Description



The RA Series offers maximum mounting and orientation flexibility in a cost-effective reduced-height package. The antenna's innovative articulating base allows it to tilt and rotate for optimum orientation. The RA mounts to a PCB via a single screw and meets Part 15 requirements.

Features

- Low cost
 - Reduced-height helical whip
 - Tilts and rotates
 - Excellent performance
 - Omni-directional pattern
 - Screw-mount
 - Use with plastic* or metal enclosures
- * Requires proximity ground plane

Electrical Specifications

- Center Freq. 433MHz
- Bandwidth 20MHz
- Wavelength 1/4-wave
- VSWR <2.0 typ. at center
- Impedance 50 ohms
- Connection Screw-mount

Electrical specifications and plots measured on 2.5" x 4" reference ground plane

Ordering Information

- ANT-433-PW-RA

VSWR Graph

